

Note 1: R4 turns clockwise to increase output reference voltage
 Note 2: R3 turns counter-clockwise to increase gain
 Note 3: Remove C1 for full 80KHz bandwidth

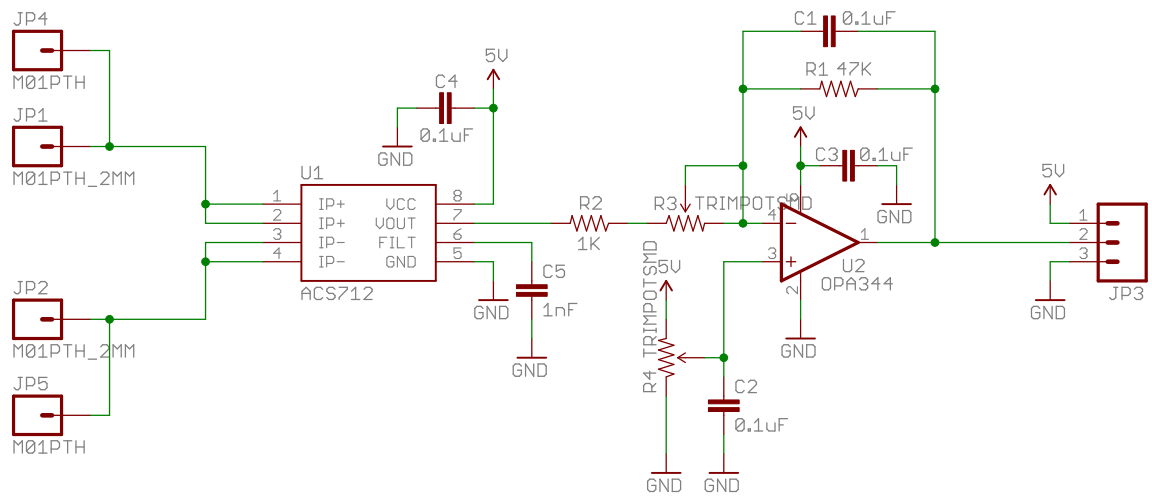

⊗ ⊗	
SFE	
TITLE: ACS712 Low Current Sensor Board v12	
Document Number:	REV:
Date: 3/31/2009 7:59:24 PM	Sheet: 1/1