

UCC = 5V or 3.3V Output
 Max Voltage Input: 16VDC
 Max Current Output: 150mA

Board is marked with combination of resonator frequency and regulator voltage.

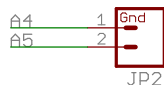
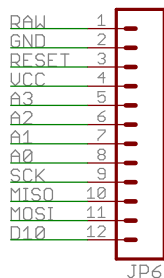
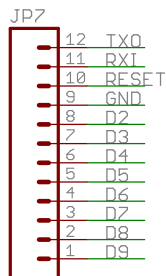
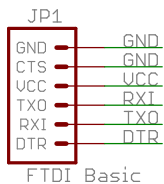
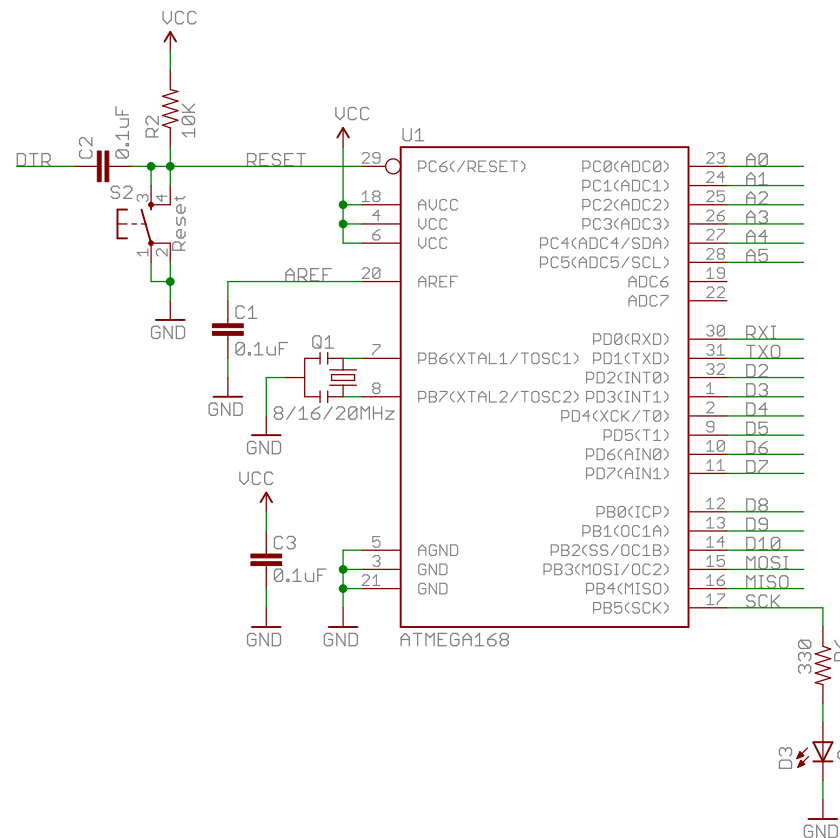

Released under the Creative Commons Attribution Share-Alike 3.0 License
<http://creativecommons.org/licenses/by-sa/3.0>

Original Arduino Mini Design by Team Arduino
 Arduino Pro Mini Design by Spark Fun Electronics

⊗ ⊗	
TITLE: Arduino-Pro-Mini-v11	SFE
Document Number:	REV:
Date: 5/26/2009 12:33:34 PM	Sheet: 1/1