

Surface Mount type 4 Direction Detector



Absolute maximum ratings (Ta=25°C)

Parameter	Symbol	Limits	Unit
Input (LED)	Forward current	50	mA
	Reverse voltage	5	V
	Power dissipation	80	mW
Output (photo-transistor)	Collector-emitter voltage	30	V
	Emitter-collector voltage	4.5	V
	Collector current	30	mA
	Collector power dissipation	80	mW
Operating temperature	Topr	-25 to +85	°C
Storage temperature	Tstg	-30 to +85	°C

Applications

DSC(Digital steal camera)
 DVC(Digital video camera)
 Digital handy phone, Fan herater,
 Projector

Features

- 1) Surface Mount type
- 2) Optical Sensor
- 3) 4 Pirection Detector

Electrical and optical characteristics (Ta=25°C)

Parameter	Symbol	Min.	Typ.	Max.	Unit	Conditions
Input charac-teristics	Forward voltage	-	1.3	1.6	V	If=50mA
	Reverse current	-	-	10	µA	VR=5V
Output charac-teristics	Dark current	-	-	0.5	µA	VCE=10V
	Peak sensitivity wavelength	-	800	-	nm	-
Transfer characteristics	Collector current	100	-	-	µA	VCE=5V, IF=5mA
	DC leakage current	-	-	15	µA	VCE=5V, IF=5mA
	Collector-emitter saturation voltage	-	-	0.4	V	IF=20mA, IC=0.1mA
	Response time	Rise time	-	10	-	µs
Fall time		-	10	-	µs	
Infrared light emitter diode	Cut-off frequency	-	1	-	MHz	IF=50mA * Non-coherent Infrared light emitting diode used.
	Peak light emitting wavelength	-	950	-	nm	
Photo transistor	Response time	-	10	-	µs	VCC=5V, IC=1mA, RL=100Ω * This product is not designed to be protected against electromagnetic wave.
	Maximum sensitivity wavelength	-	800	-	nm	

Electrical and optical characteristics curves

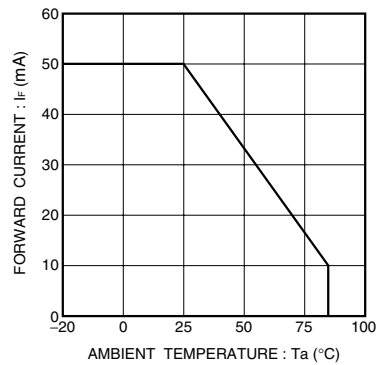

Fig.1 Forward current falloff

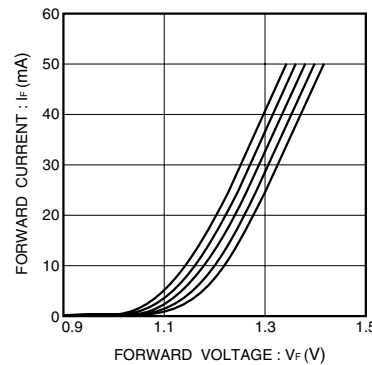

Fig.2 Forward current vs. forward voltage

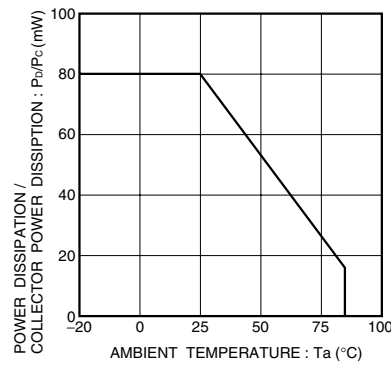

Fig.3 Power dissipation / collector power dissipation vs. ambient temperature

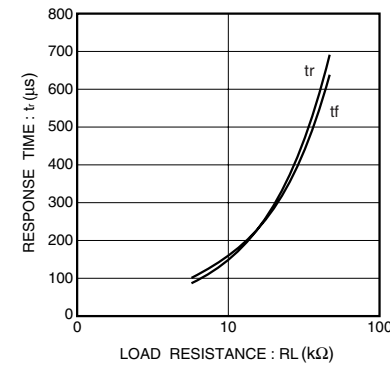

Fig.7 Response time vs. collector current

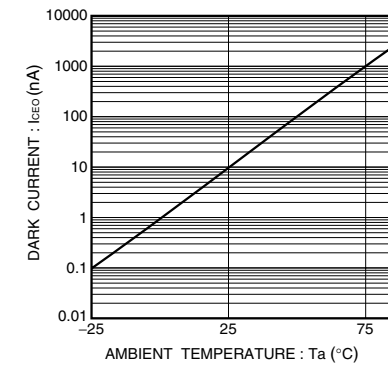

Fig.8 Dark current vs. ambient temperature

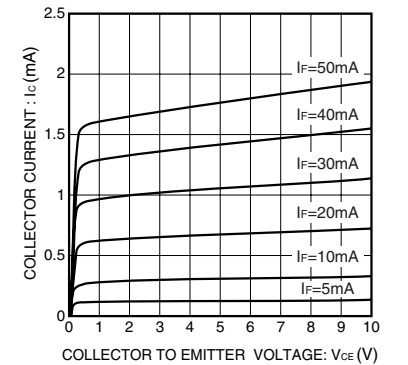

Fig.9 Output characteristics

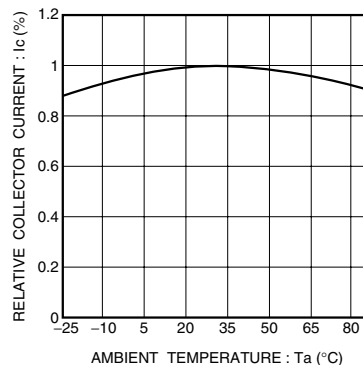

Fig.4 Relative output vs. ambient temperature

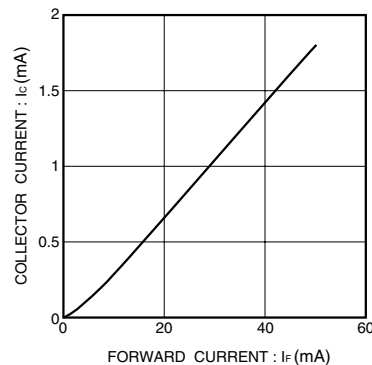

Fig.5 Collector current vs. forward current

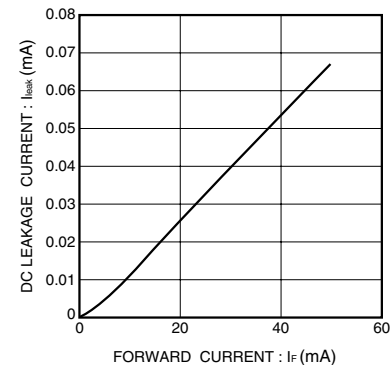

Fig.6 DC leakage current vs. forward current

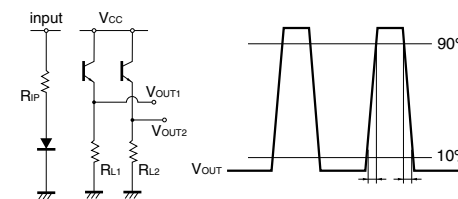
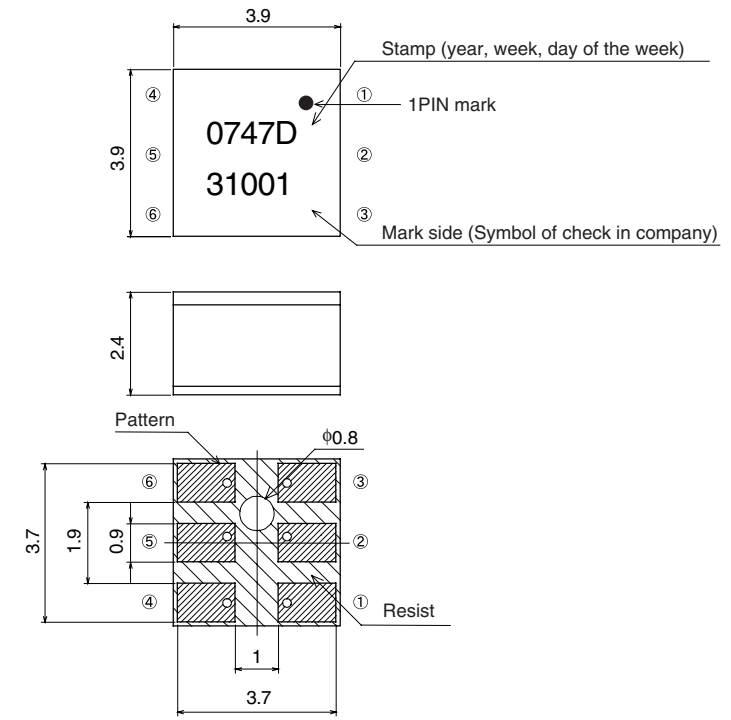
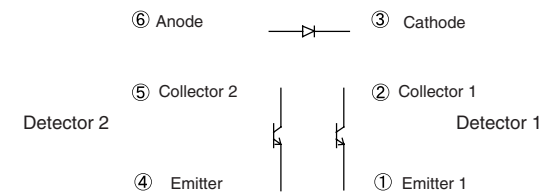

Fig.10 Response time measurement circuit

Dimensions (Unit : mm)



Internal connection diagram



Notes:

- 1. Unspecified tolerance shall be ±0.2 .
- 2. Dimension in parenthesis are show for reference.

Notes

- No technical content pages of this document may be reproduced in any form or transmitted by any means without prior permission of ROHM CO.,LTD.
- The contents described herein are subject to change without notice. The specifications for the product described in this document are for reference only. Upon actual use, therefore, please request that specifications to be separately delivered.
- Application circuit diagrams and circuit constants contained herein are shown as examples of standard use and operation. Please pay careful attention to the peripheral conditions when designing circuits and deciding upon circuit constants in the set.
- Any data, including, but not limited to application circuit diagrams information, described herein are intended only as illustrations of such devices and not as the specifications for such devices. ROHM CO.,LTD. disclaims any warranty that any use of such devices shall be free from infringement of any third party's intellectual property rights or other proprietary rights, and further, assumes no liability of whatsoever nature in the event of any such infringement, or arising from or connected with or related to the use of such devices.
- Upon the sale of any such devices, other than for buyer's right to use such devices itself, resell or otherwise dispose of the same, no express or implied right or license to practice or commercially exploit any intellectual property rights or other proprietary rights owned or controlled by
- ROHM CO., LTD. is granted to any such buyer.
- Products listed in this document are no antiradiation design.

The products listed in this document are designed to be used with ordinary electronic equipment or devices (such as audio visual equipment, office-automation equipment, communications devices, electrical appliances and electronic toys).

Should you intend to use these products with equipment or devices which require an extremely high level of reliability and the malfunction of which would directly endanger human life (such as medical instruments, transportation equipment, aerospace machinery, nuclear-reactor controllers, fuel controllers and other safety devices), please be sure to consult with our sales representative in advance.

It is our top priority to supply products with the utmost quality and reliability. However, there is always a chance of failure due to unexpected factors. Therefore, please take into account the derating characteristics and allow for sufficient safety features, such as extra margin, anti-flammability, and fail-safe measures when designing in order to prevent possible accidents that may result in bodily harm or fire caused by component failure. ROHM cannot be held responsible for any damages arising from the use of the products under conditions out of the range of the specifications or due to non-compliance with the NOTES specified in this catalog.

Thank you for your accessing to ROHM product informations.

More detail product informations and catalogs are available, please contact your nearest sales office.

ROHM Customer Support System

THE AMERICAS / EUROPE / ASIA / JAPAN

www.rohm.com

Contact us : webmaster@rohm.co.jp